

OC 9124

## MASTER KIT EMPORTE-PIECES CAPTEURS DE STATIONNEMENT VW (24 PCS)

REAR PARKING SENSOR PUNCH MASTER TOOL KIT VW (24 PCS)





### ATTENTION

Avant de retourner ce produit pour quelque raison qu'il soit (problème d'installation, consignes d'utilisation, panne, problème de fabrication...), merci de nous contacter.

Contact :

Vous pouvez nous joindre par mail à [sav@clas.com](mailto:sav@clas.com) ou bien au 04 79 72 92 80 ou encore vous rendre directement sur notre site [clas.com](http://clas.com)

Si vous avez changé d'avis concernant votre achat, veuillez retourner ce produit avant d'essayer de l'installer.

### WARNING

Before returning this product for any reason (installation problem, instructions for use, breakdown, manufacturing problem...), please contact us.

Contact :

You can reach us by mail [sav@clas.com](mailto:sav@clas.com) or by phone +33(0)4 79 72 69 18 or go directly to our website [clas.com](http://clas.com)

If you have changed your mind regarding your purchase, please return this product before you attempt to install it.

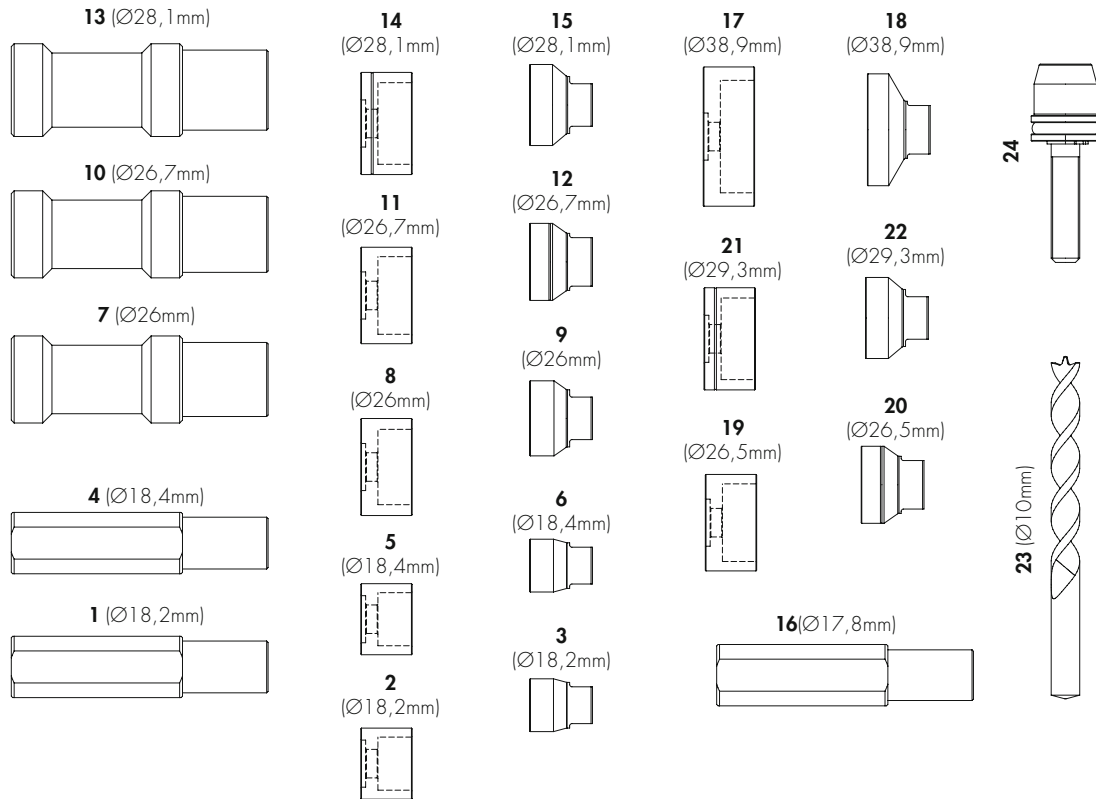

COMPOSANTS

1	FICHE DE CENTRAGE Ø18,2 MM	
2	GUIDE Ø18,2 MM	
3	POINÇON Ø18,2 MM	
4	FICHE DE CENTRAGE Ø18,4 MM	
5	GUIDE Ø18,4 mm	
6	POINÇON Ø18,4 mm	
7	FICHE DE CENTRAGE Ø26 mm	
8	GUIDE Ø26 mm	

## COMPOSANTS

9	POINÇON Ø26 mm	
10	FICHE DE CENTRAGE Ø26,7 mm	
11	GUIDE Ø26,7 mm	
12	POINÇON Ø26,7 mm	
13	FICHE DE CENTRAGE Ø28,1 mm	
14	GUIDE Ø28,1 mm	
15	POINÇON Ø28,1 mm	
16	FICHE DE CENTRAGE Ø17,8 mm	
17	GUIDE Ø38,9 mm	
18	POINÇON Ø38,9 mm	
19	GUIDE Ø26,5 mm	
20	POINÇON Ø26,5 MM	
21	GUIDE Ø29,3 mm	
22	POINÇON Ø29,3 mm	
23	POINTE Ø10	
24	OUTIL AVEC ROULEMENT POUR POINÇON 3/8" - M10X1	



## INTRODUCTION

Avant de commencer toute action, il est impératif de lire le présent manuel d'utilisation.

La garantie du bon fonctionnement et la conformité des performances du produit relèvent directement du respect de toutes les instructions fournies dans le présent manuel.

La société garantit la conformité du produit aux spécifications techniques décrites dans le présent manuel.

Le producteur décline toute responsabilité pour tout usage impropre, autre que les usages décrits.

Utiliser des gants anti-accident, des chaussures anti-accident, un casque de protection et des lunettes de protection.



Usage impropre:

- Le produit ne doit être utilisé que pour l'usage prévu dans la présente documentation. Tout autre usage doit être considéré comme impropre.
- Le producteur décline toute responsabilité pour tout dommage découlant d'usages erronés ou irraisonnables de l'équipement.
- L'usage impropre annule la garantie.



Prendre bien soin des outils:

- Toujours garder les outils bien propres.
- Ranger les outils dans leur emballage d'origine.

## DESCRIPTION

Le kit décrit dans le présent manuel est utilisé pour percer des orifices propres et sans bavures dans les pare-chocs en plastique. Cela est nécessaire lorsque le pare-chocs de rechange fourni par le constructeur ne présente pas d'orifices pour le montage des capteurs de stationnement.

Selon les instructions de réparation de certains constructeurs, les orifices ne doivent être percés qu'après l'application de la peinture afin d'assurer, après la réparation, un aspect le plus proche possible de l'original.

De plus, les goupilles de centrage fournies dans le kit garantissent, lors de la fixation (soudage/collage), la fixation exacte et l'alignement des supports des capteurs.

Le kit présente une sélection des dimensions les plus utilisées, y compris les tailles intermédiaires impaires prescrites par un certain nombre de constructeurs. Il convient pour les capteurs de stationnement standard (PDC=Park-Distance-Control) et pour les capteurs d'aide au stationnement (PLA=Parking Assistant).

Les numéros OEM indiqués ne servent qu'à l'attribution des données techniques et des domaines d'application!

**MODE D'EMPLOI**

Respecter toujours les indications et les instructions de réparation du constructeur du véhicule!

- ⚠ • La position des capteurs est généralement marquée en usine par des repères à l'intérieur du pare-chocs. (Figures 1+2). Il est possible que le kit de montage contienne un gabarit adapté au véhicule et/ou au pare-chocs.

1

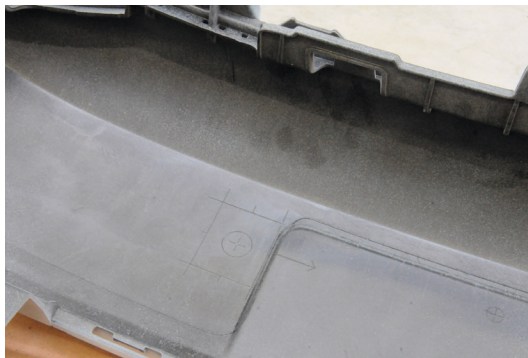

2

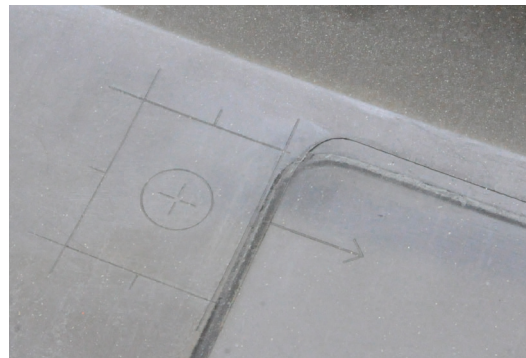

- Percer un orifice avec un foret Ø10mm pour chaque repère sur le pare-chocs. Placer la perceuse exactement au milieu du repère et percer de l'intérieur vers l'extérieur. (Fig.3)
- Choisir la douille adaptée à l'orifice et l'insérer sur l'axe fileté doté de roulement. L'ouverture de la matrice doit être orientée dans la direction opposée au roulement (Fig.4).

3



4



- Insérer l'unité d'actionnement avec la partie fileté dans l'orifice préalablement percé dans le pare-chocs. (Fig.5)
- Visser le poinçon sur le filetage de l'unité d'actionnement. (Fig.6+7)

5



6





7



8



- Utiliser une clé à cliquet de 3/8" et, pour fixer le poinçon de l'extérieur, une clé à molette. Le poinçon est introduit dans la douille par vissage (Figures 8+9). En opérant de l'extérieur vers l'intérieur, un orifice propre et sans bavures est créé dans le pare-chocs. (Fig.10)

9



10



- S'assurer que l'axe de centrage est parfaitement adapté au support du capteur. (Fig.11)
- De l'extérieur, insérer l'axe de centrage approprié dans l'orifice que l'on vient de percer dans le pare-chocs. (Fig.12).

11



12



- De l'intérieur, placer le support du capteur directement sur l'axe (Fig.13). Commencer la fixation du support selon la procédure prescrite par le constructeur.

13





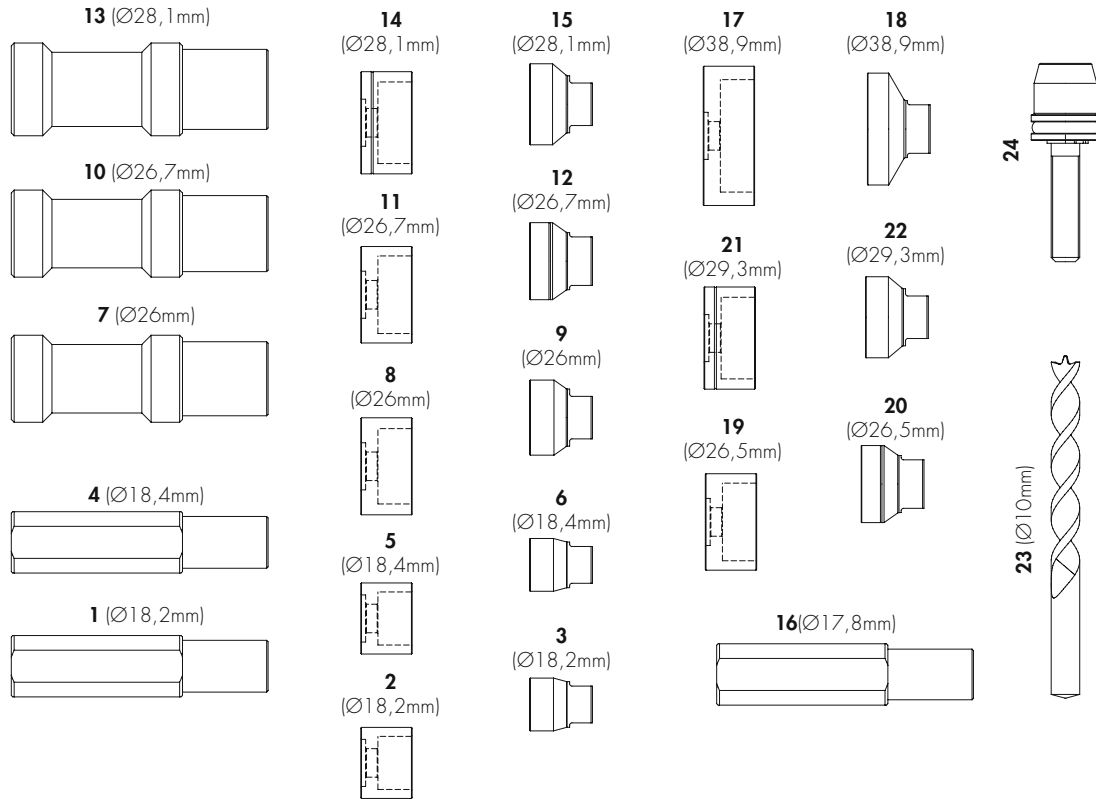

















COMPONENTS

1	PILOT BEARING ADAPTORS Ø18,2 mm	
2	GUIDE TOOL Ø18,2 mm	
3	DRIFT TOOL Ø18,2 mm	
4	PILOT BEARING ADAPTORS Ø18,4 mm	
5	GUIDE TOOL Ø18,4 mm	
6	DRIFT TOOL Ø18,4 mm	
7	PILOT BEARING ADAPTORS Ø26 mm	
8	GUIDE TOOL Ø26 mm	

**OC 9124****REAR PARKING SENSOR PUNCH MASTER TOOL KIT VW  
(24 PCS)****COMPONENTS**

9	DRIFT TOOL Ø26 mm	
10	PILOT BEARING ADAPTORS Ø26,7 mm	
11	GUIDE TOOL Ø26,7 mm	
12	DRIFT TOOL Ø26,7 mm	
13	PILOT BEARING ADAPTORS Ø28,1 mm	
14	GUIDE TOOL Ø28,1 mm	
15	DRIFT TOOL Ø28,1 mm	
16	PILOT BEARING ADAPTORS Ø17,8 mm	
17	GUIDE TOOL Ø38,9 mm	
18	DRIFT TOOL Ø38,9 mm	
19	GUIDE TOOL Ø26,5 mm	
20	DRIFT TOOL Ø26,5 mm	
21	GUIDE TOOL Ø29,3 mm	
22	DRIFT TOOL Ø29,3 mm	
23	DRILL Ø10 mm	
24	TOOL 3/8" - M10X1	



## INTRODUCTION

It is compulsory to read this instruction manual before starting any kind of action.

The proper operation and full compliance of this product's performance is guaranteed only if all the instructions provided in this manual are closely adhered to.

We guarantee that this product complies with the technical specifications described in this manual.

The manufacturer shall not be held responsible for any improper uses other than those described herein. Use protective work gloves, protective footwear, hard hat and safety goggles.



Misuse:

- This product should only be used as described in this documentation; any other use is considered improper.
- The manufacturer accepts no responsibility for any damage caused by the incorrect or unreasonable use of the equipment.
- Moreover, misuse shall also void the warranty.



Take care of your tools:

- Be sure to store your tools in a clean state.
- Place the tools inside their original package.

## DESCRIPTION

The tool set described in this manual is used to make clean holes in plastic bumpers without burrs. This is necessary when the replacement bumper supplied by the manufacturer does not have the holes for mounting the parking sensors.

According to some manufacturers' repair instructions, holes should be drilled only after painting to guarantee, once repaired, an appearance as close to the original as possible.

Furthermore, the centering pins contained in the tool set ensure the correct fixing and alignment of the sensor supports during fastening (welding/gluing).

This tool set features a choice of the most used measures, also including odd intermediate measures, as prescribed by different manufacturers. It is suitable for standard parking sensors (PDC=Park-Distance-Control) and for parking assistance sensors (PLA=Parking Assistant).



The OEM numbers shown are used only for assigning technical data and fields of use!

## INSTRUCTIONS



Always adhere to the vehicle manufacturer's recommendations and repair instructions!

- As a rule, the position of the sensors is marked by the manufacturer with markings on the inside of the bumpers (Figures 1+2). The supplied assembly tool set may contain a template suitable for the vehicle and/or the bumper.

1

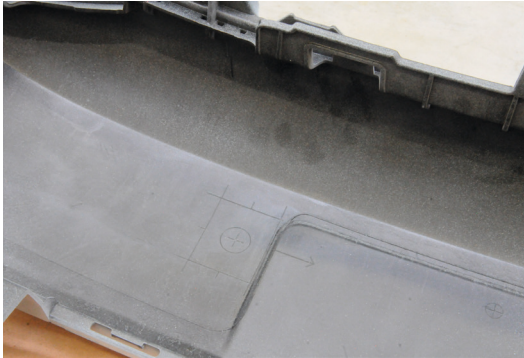

2



- Use a  $\varnothing 10$  mm drill to drill a hole for each marking on the bumper. Place the drill exactly in the middle of the marking and drill from the inside to the outside (Fig.3)
- Select the bushing suitable for the hole and insert it on the threaded pin with bearing. The opening of the matrix should face the direction opposite the bearing (Fig.4).

3



4



- Insert the drive unit with the threaded part into the hole previously drilled in the bumper (Fig.5).
- Screw the punch on the drive unit's thread (Figures 6+7).

5



6



7



8



- Use a 3/8" ratchet wrench and then a monkey wrench to lock the punch from the outside. The punch is pulled into the bushing as it is screwed (Figures 8+9). A clean hole is created in the bumper without burrs by working from the outside towards the inside (Fig.10).

9



10

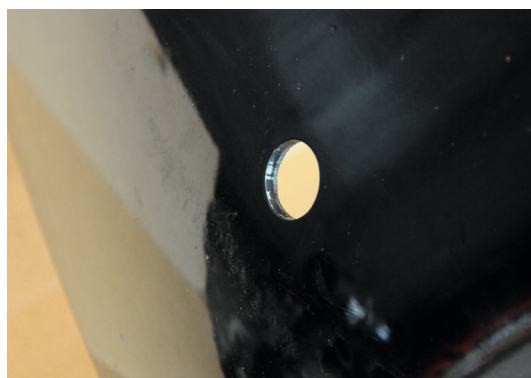

- Ensure the centering pin is perfectly suited to the sensor support (Fig.11).
- From the outside, insert the appropriate centering pin into the hole of the newly cut bumper (Fig.12).

11



12





- From the inside, place the sensor support directly on the pin (Fig.13).  
Start fixing the support by following the procedure recommended by the manufacturer.

13







**CLAS Equipements**

ZA de la CROUZA  
73800 CHIGNIN  
FRANCE

Tél. +33 (0)4 79 72 62 22  
Fax. +33 (0)4 79 72 52 86

**OC 9124**

**MASTER KIT EMPORTE-PIECES CAPTEURS DE STATIONNEMENT  
VW (24 PCS)**

**REAR PARKING SENSOR PUNCH MASTER TOOL KIT VW (24 PCS)**

---

Si vous avez besoin de composants ou de pièces, contactez le revendeur  
En cas de problème veuillez contacter le technicien de votre distributeur agréé

---

If you need components or parts, please contact the reseller.  
In case of problems, please contact your authorized technician.